

# **SOGEVAC®**

## **SV40-65 BI FC**

Single-stage, oil-sealed rotary vane pump

Original Operating instructions 300452480\_002\_C1  
and spare parts list

Part-Nr:  
960359V01  
960361V01  
960362V01  
960363V01  
960363V013001  
960461V01ES  
960462V01  
960463V01  
960465V013001  
960465V013002  
960466V01  
and other variants

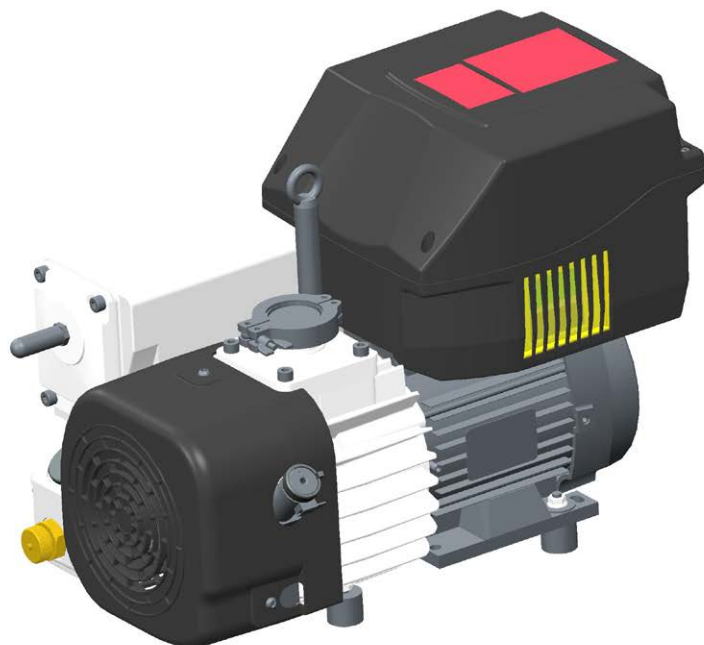

# Contents

	<b>Page</b>
<b>Important Safety Information</b>	<b>3</b>
<b>1 Description</b>	<b>6</b>
1.1 Principle of operation	6
1.2 Technical characteristics	7
1.3 Accessories	10
1.4 Lubricants	10
1.5 Ordering information	10
<b>2 Transport and Storing</b>	<b>12</b>
2.1 Transport and packaging	12
2.2 Mounting orientation	12
2.3 Storing	12
<b>3 Installation</b>	<b>13</b>
3.1 Setting up	13
3.2 Electrical connections	14
3.3 Oil filling	16
3.4 Start-up	16
<b>4 Operation</b>	<b>16</b>
4.1 Operation	16
4.2 Working in cycles in / out	17
4.3 Switching off / Shutdown	18
4.4 Conditions of use	18
4.5 Taking out of use	18
<b>5 Maintenance</b>	<b>19</b>
5.1 Safety Information	19
5.2 Maintenance Intervals	19
5.3 Leybold Service	20
5.4 Maintenance Work	20
<b>6 Troubleshooting</b>	<b>22</b>
<b>7 Spare parts</b>	<b>24</b>
<b>EC Conformance Declaration</b>	<b>27</b>
<b>Declaration of Contamination of Compressors, Vacuum Pumps and Components</b>	<b>28</b>

## Important Safety Information

Indicates procedures that must be strictly observed to prevent hazards to persons.

Indicates procedures that must be strictly observed to prevent damage to, or destruction of the product.

Emphasizes additional application information and other useful information provided within these Operating Instructions.

The Leybold Sogevac® has been designed for safe and efficient operation when used properly and in accordance with these Operating Instructions. It is the responsibility of the user to carefully read and strictly observe all safety precautions described in this section and throughout the Operating Instructions. The Sogevac® must only be operated indoor. In proper condition and under the conditions described in the Operating Instructions. If not, the protection provided by the equipment may be impaired. It must be operated and maintained by trained personnel only. Consult local, state, and national agencies regarding specific requirements and regulations. Address any further safety, operation and/or maintenance questions to our nearest office.

### **Failure to observe the following precautions could result in serious personal injury!**

Sogevac® pumps are not designed:

- for pumping of dusty, aggressive, corrosive, flammable or explosive gases or gases mixtures,
- for pumping of oxygen or other highly reactive gases with a greater concentration than atmospheric concentration (>20%),
- for working in flammable, explosive or dusty environment.

For all these cases, special materials must be used. In case of doubt, please contact Leybold.

See also the limits of use indicated in the CE declaration of conformity.

Never expose part of the body to the vacuum. There is a danger of injury. Never operate the pump with an open and thus accessible inlet. Vacuum connections as well as oil filling and oil draining openings must not be opened during operation of the pump.

Depending on the process involved, dangerous substances and oil may escape from the pump. Take the necessary safety precautions !

### **Disconnect the unit from the power supply before starting any work.**

Pump must not be operated above 2000 m sea level.

---

### Warning

---

### Caution

---

### Note

---

### Warning



# Safety Information

---

## Warning



The Sogevac® vacuum pumps have been manufactured according to the latest technical standards and safety regulations. If not installed properly or not used as directed, dangerous situations or damages could occur.

It is mandatory that these operating instructions be read and understood prior to vacuum pump installation and start-up.

### **The pump complies to the standard EN 61010-1.**

High electric voltages! When touching parts at high electric voltages, there is the risk of suffering severe injuries by an electric shock! Covers marked with this symbol must only be opened by trained electricians after having reliably deenergised (lockout/tagout) the equipment.

Always operate the pump with a properly connected protective earth conductor and make sure that the motor & FC connection box are closed.

Use only the Leybold frequency converter for the pumps equipped with one.

After having made changes to the wiring, check the motor's direction of rotation.

Lay the connecting lines so that these cannot be damaged. Protect the lines against humidity and contact with fluids. Avoid thermally stressing the lines by unfavourable laying. Provide strain relief for the connecting lines so that the plugs and the line connectors are not subjected to excessively high mechanical stresses.

Lay electric feed lines so that there is no risk of tripping over these.

Take appropriate precautions to insure that the pump cannot start.

If the pump has pumped hazardous gases it will be absolutely necessary to determine the nature of the hazard involved and take the appropriate safety precautions.

Observe all safety regulations!

Take adequate safety precautions prior to opening the intake or exhaust port.

---

## Warning



---

## Caution

### **Failure to observe the following precautions could result in damage to the equipment!**

Liquid and solid particles must not enter the pump. Install the adequate filters, separators and/or condensers. In case of doubt consult Leybold.

The intake line of the pump must never be connected to a device with over atmospheric pressure. Design the exhaust line so that no pressure higher than 1,15 bar abs. (0,15 bar rel.) can occur.

Operating of the pump without oil or operating with incorrect direction of rotation can destroy the pump.

Never use discarded seals. Always assemble using new seals.

# Safety Information

Respect the instructions concerning environment protection when discarding used oil or exhaust filters!

The pump must be packaged in such a way that it will not be damaged during shipping, and so that no harmful substances can escape from the package.

We reserve the right to alter the design or any data given in these Operating Instructions. The illustrations are not binding.

**Caution :** hot surface ! In normal operation, the pump surface temperature can reach 85°C. There is a risk of burning. Switch off the pump and let it cool down before any intervention or take appropriate precautions. It is recommended to use an oil casing or pump touching protection at high ambient temperatures.

As a touching protection, you can use the “Noise enclosure for SV40 BI + 65 BI FC” P/N 960331NENC. The noise enclosure is an accessory not included in the pump delivery.

All work on a pump which is “still warm from operation” should be done only whilst wearing protective gloves.

Handle the pump only while vented and after having let it cool down.

Never remove the oil-fill or oil-drain plugs while the pump is running. There exists the risk of suffering burns. Always wear protective gloves and protective goggles also for protection against the oil.

Some pumps use perfluoropolyether (PFPE) as lubricant.

When handling PFPE you should observe the following:  
During thermal decomposition at temperatures over 290 °C toxic and corrosive gases are released. This is not likely to happen in a Sogevac® pump. When handling PFPE keep it way from open fires. Do not smoke with PFPE on your fingers.

Touch the inner sections of the pumps only while wearing clean gloves, and use clean tools; do the necessary work in clean and dry rooms.

Do not allow the ingestion of any objects (screws, welding beads, nuts, washers, pieces of wire, fittings etc.) through the intake port of the pump.

Objects falling into the pump can cause severe damage.

---

## Caution



---

## Caution



---

## Warning



# Description

## 1 Description

Sogevac® pumps are designed for pumping of inert gases in the range of rough vacuum, between atmospheric pressure and ultimate pressure of the pump.

When removing condensable vapours, periodic opening of the gas ballast valve is required.

### 1.1 Principle of operation

The Sogevac® pumps are single-stage oil-sealed rotary vane vacuum pumps. The rotor, having three slots in which the vanes are sliding, is eccentrically installed in a pump cylinder (stator).

The vanes separate the interior space into 3 chambers. The volume of these chambers varies with the rotation of the rotor.

The gas sucked into the inlet chamber is compressed and then pushed out at the exhaust valve.

The oil injected in the inlet chamber guarantees the air-tightness, the lubrication and cooling of the pump. It is dragged off by the compressed gases and roughly separated by gravity when entering in the oil sump. A fine separation is then operated in the exhaust filter. An internal transfer pushes the collected oil back into the vacuum generator, the transfer is operated by a float valve to avoid atmospheric air coming from the oil casing to the inlet of the pump when no oil is present in the recovery system.

The oil circulation functions by differential pressures.

The pumps are equipped with a gas ballast valve for pumping condensable vapours.

The anti suckback valve at the inlet flange avoids oil coming back into the inlet line when the pump is stopped. This is valid for working pressures below 100 mbar and under the condition that the valve is kept clean and in good condition. The anti suck-back valve is not a safety valve. If oil back flowing is to be avoided by all means, it is necessary to mount a separate safety valve on the pump inlet.

Some variants are equipped with a frequency converter giving a constant pumping speed independently of the mains frequency and regulating the pump power consumption. At high inlet pressures, the pump speed is decreased.

The pump speed can be reduced to 900 rpm (idle mode) to reduce the power consumption w/o loss of end pressure on some pump variants. In this idle mode, the pump inlet pressure must remain below 10 mbar.

## Information to user

The user's manual or instruction manual for an intentional or unintentional radiator shall caution the user that changes or modifications not expressly approved by the party responsible for compliance could void the user's authority to operate the equipment.

Note : This equipment has been tested and found to comply with the limits for a Class B, group 1 digital device, pursuant to part 15 of the FCC Rules. These limits are designed to provide reasonable protection against harmful interference when the equipment is operated in a commercial environment. This equipment generates, uses, and can radiate radio frequency energy and, if not installed and used in accordance with the instruction manual, may cause harmful interference to radio communications. Operation of this equipment in a residential area is likely to cause harmful interference in which case the user will be required to correct the interference at his own expense.

This product has been tested to the requirements of CAN/CSA-C22.2 No. 61010-1, third edition, including Amendment 1, or a later version of the same standard incorporating the same level of testing requirements

## 1.2 Technical characteristics

### SV40 BI FC

Technical data		50 Hz & 60 Hz
Nominal pumping speed	m <sup>3</sup> /h	≥ 53
Pumping speed (according to PNEUROP)	m <sup>3</sup> /h à 2 mbar	≥ 36
Ultimate partial pressure without gas ballast	mbar	≤ 0,2
Ultimate total pressure with small gas ballast	mbar	≤ 1,0
Water vapour tolerance:		
■ with small gas ballast approx.	mbar	10
Water vapour tolerable load:		
■ with small gas ballast approx.	kg.h <sup>-1</sup>	0,34
Noise level (according to DIN 46 635)	dB (A)	≤ 59
Motor power - Rated rotational speed	kW - min <sup>-1</sup>	1,6-1800
Mains voltage (+/- 10 %) AC ~	V	200 ... 240
Protection - Insulation <sup>1)</sup>		IP 20 - F
Leak rate	mbar.l.s <sup>-1</sup>	1 x 10 <sup>-3</sup>
Ambient temperature	°C	18 ... 40

See pump nameplate for further data.

<sup>1)</sup> Given by power & interface connections.

# Description

## SV65 BI FC

Technical data	50 Hz & 60 Hz	
Nominal pumping speed	m <sup>3</sup> /h	71
Pumping speed (Norme PNEUROP)	m <sup>3</sup> /h à 2 mbar	≥ 50
Ultimate partial pressure without gas ballast	mbar	≤ 0,2
Ultimate total pressure with small gas ballast	mbar	≤ 1,0
Water vapour tolerance: ■ with small gas ballast approx.	mbar	10
Water vapour tolerable load: ■ with small gas ballast approx.	kg.h <sup>-1</sup>	0,41
Noise level (Norme DIN 46 635)	dB (A)	≤ 60
Motor power - Rated rotational speed	kW - min <sup>-1</sup>	1,5-1800
Mains voltage (+/- 10 %) AC ~	V	200 ... 240
Protection - Insulation <sup>1)</sup>		IP 20 - F
Leak rate	mbar.l.s <sup>-1</sup>	<1 x 10 <sup>-3</sup>
Ambient temperature	°C	18 ... 40

See pump nameplate for further data.

<sup>1)</sup> Given by power & interface connections.



# Description

## SV40 BI FC & SV65 BI FC

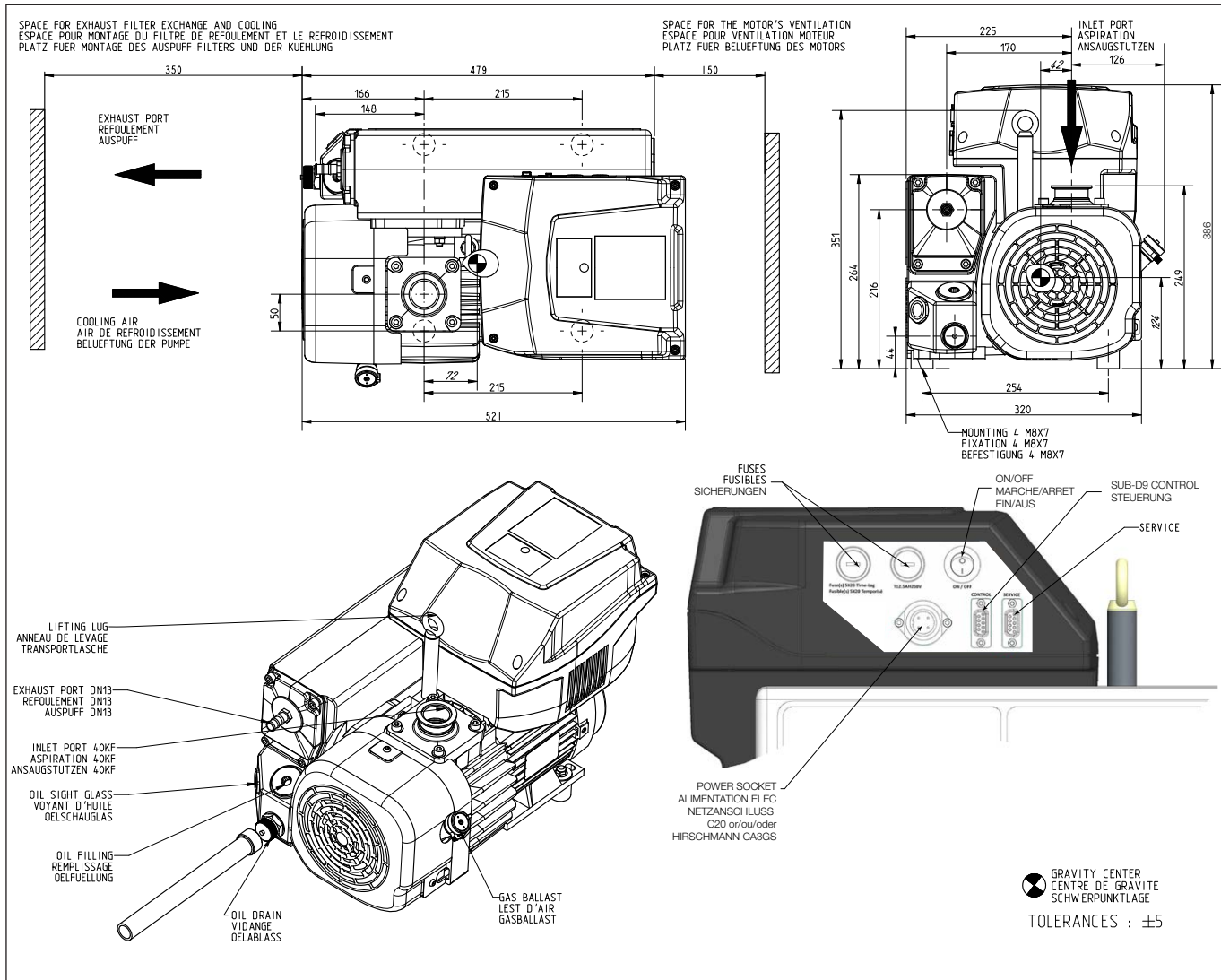

1 Pa = 10<sup>-2</sup> mbar

1 Torr = 1,33 mbar

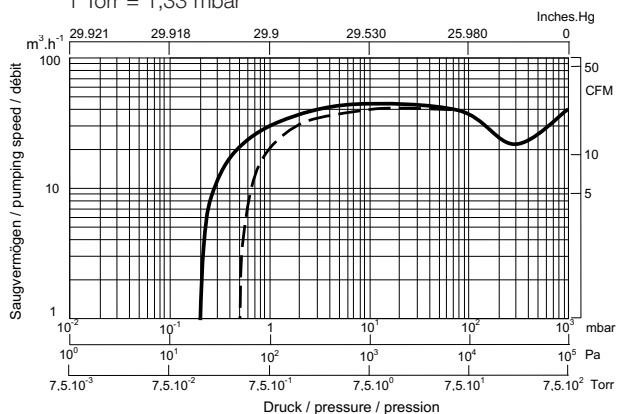

bei / at / à 50 & 60 Hz

Saugvermögenskurven  
Pumping speed (volume flow rate)  
Courbes de débit

— ohne Gasballast  
without gas ballast  
sans lest d'air

- - - mit Gasballast  
with gas ballast  
avec lest d'air

**SV40 BI FC**

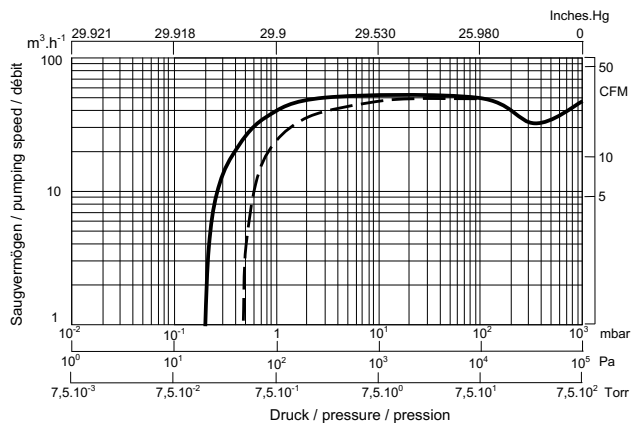

bei / at / à 50 & 60 Hz

Saugvermögenskurven  
Pumping speed (volume flow rate)  
Courbes de débit

— ohne Gasballast  
without gas ballast  
sans lest d'air

- - - mit Gasballast  
with gas ballast  
avec lest d'air

**SV65 BI FC**

# Description

## 1.3 Accessories

Specification	Cat. Nr.
Adapter for tubing	712 41 608
Hex key metric male 12 mm	E6507617
Mobile base frame with handles and oil pan	960560WB
Mobile base frame with oil pan	960331BASE
Noise enclosure	960331NENC

## 1.4 Lubricants

The Sogevac® pumps should be run with vacuum pump oils with a viscosity according to ISO category VG32. Use only the Leybold oil indicated on the name plate and pump. In case other oils are used, Leybold rejects all responsibility should any trouble occur.

Oil	Conditioning	Reference
Ester LVO200	1 l	L 200 01
Ester LVO200	2 l	L 200 02
Ester LVO200	5 l	L 200 05
Ester LVO200	20 l	L 200 20
PFPE LVO420	1 l	L 420 01
Synthetic LVO700	1 l	L 700 01

## 1.5 Ordering information

P/N	Pump	GB	Inlet	Exhaust	Oil	Shaft seal	Sub-D type	Control	Mains socket type	On/Off switch	Current overload
960359V01	SV40 BI FC	Y1	40 KF	25 KF	LVO 700	Dynamic	9 Female	RS485	HIRSCHMANN: CA3GS	Yes	2 Fuses 12.5 A
960361V01	SV40 BI FC	Y1	25 KF	25 KF	LVO 200	Dynamic	9 Female	RS485	HIRSCHMANN: CA3GS	Yes	2 Fuses 12.5 A
960362V01	SV40 BI FC	Y1	25 KF	25 KF	PFPE LVO 420	PTFE	9 Female	RS485	HIRSCHMANN: CA3GS	Yes	2 Fuses 12.5 A
960363V01	SV40 BI FC	Y1	25 KF	1/2 Barbed hose fitting	LVO 200	Dynamic	M8	Analog dry contact	HIRSCHMANN: CA3GS	No	2 Fuses 12.5 A
960363V013001	SV40 BI FC	Y1	40 KF	1/2 Barbed hose fitting	LVO 200	Dynamic	9 Male	Analog pins 9 and 8	C20	No	2 Fuses 12.5 A
960461V01ES	SV65 BI FC	N	40 KF	40 KF	LVO 200	Dynamic	9 Female	RS485	HIRSCHMANN: CA3GS	Yes	2 Fuses 12.5 A
960462V01	SV65 BI FC	Y1	40 KF	40 KF	PFPE LVO 420	PTFE	9 Female	RS485	HIRSCHMANN: CA3GS	Yes	2 Fuses 12.5 A
960463V01	SV65 BI FC	Y1	40 KF	1/2 Barbed hose fitting	LVO 200	Dynamic	9 Male	Analog pins 9 and 8	C20	No	2 Fuses 12.5 A
960465V013001	SV65 BI FC	Y1	40 KF	1/2 Barbed hose fitting	LVO 200	Dynamic	9 Male	Analog pins 9 and 8	HIRSCHMANN: CA3GS	No	2 Fuses 12.5 A
960465V013002	SV65 BI FC	Y1	40 KF	1/2 Barbed hose fitting	LVO 200	Dynamic	9 Male	Analog pins 9 and 8	HIRSCHMANN: CA3GS	No	2 Fuses 12.5 A
960466V013001	SV65 BI FC	Y1	40 KF	15 mm straight hose fitting	LVO 700	Dynamic	9 Female	Analog pins 9 and 8	HIRSCHMANN: CA3GS	No	2 Fuses 12.5 A

Motor: Single phase 200-240 V +/-10% 50 Hz and 60 Hz power supply with frequency drive

Gas ballast: GB Y1 =0,5 m³/h

## Power cords

P/N	Plug pump side	Plug supply side	Length m
971457EUR	Hirschmann	Euro / Schuko 16 A	2.5
971457GB	Hirschmann	UK plug 13 A	2.5
971457NEMA	Hirschmann	NEMA 6-15P 250 V	2.5
971457CH	Hirschmann	Swiss plug 10 A	2.5
971457WW	Hirschmann	w/o	2.5
EK6506966	Hirschmann	IEC 309 16 A	5
EK6510715	Hirschmann	C20	2.5
EK6520102	Hirschmann	Cable shoes 5 mm	2.8
EK6510720	Hirschmann	C14	2.5
140304	C19	NEMA 5-15P 125 V	1.8
140305	C19	NEMA 6-15P 250 V	1.8
140306	C19	Euro / Schuko 16 A	1.8
140307	C19	UK plug 13 A	1.8
E6500825	C19	C20	2.5
E6505883	C19	IEC 309 16 A	5
EK6502798	C19	C14	2.5

# Transport and storing

## 2 Transport and Storing

### 2.1 Transport and packaging

Sogevac® vacuum pumps pass a rigorous operating test in our factory and are packaged to avoid transport damages. Indications on the packaging must be observed.

Please check packaging on delivery for transport damages.

The outer package bears a shock indicator, turning red at 50 g. Should the shock indicator have reacted, a transportation damage may have occurred and the freight forwarder must be advised.

Packing materials should be disposed off according to environmental laws or re-cycled. These operating instructions are part of the consignment.

The connection ports are blanked off by plastic protective caps or self-adhesives. Take these caps or self-adhesives away before turning on the pump.

### 2.2 Mounting orientation

See required space on drawings in paragraph 1.2.

Pumps which have been filled with oil must only be moved in the upright position (horizontally). Otherwise oil may escape. The angle of slope may not be over 10° max. Avoid any other orientations while moving the pump.

Only use the lifting lugs which are provided on the pump to lift the pump with the specified lifting devices.

Make sure that these have been installed safety. Use suitable lifting equipment. Make sure that all safety regulations are observed.

Use only lifting devices appropriated to the pump weight. Check name plate. Do not use other pump elements than the lifting lugs as handles.

### 2.3 Storing

Before stocking the pump for a long time put it back in its original condition (blank off inlet and exhaust ports with the shipping seals, drain the oil) and store the pump in a dry place at room temperature.

Storage temperature: - 15°C to + 50°C.

Until the pump is put back in to service again, the pump should be stored in a dry place, preferably at room temperature (20 °C - 168 °F). Before taking the pump out of service, it should be properly disconnected from the vacuum system, purged with dry nitrogen and the oil should be exchanged too. The gas ballast must be closed and if the pump is to be shelved for a longer period of time it should be sealed in a plastic bag together with a desiccant (Silicagel).

If the pump has been shelved for over one year, standard maintenance must be done and the oil must be exchanged too before the pump is put in to service once more.

We recommend that you contact the service from Leybold.

---

#### Caution

---

## 3 Installation

It is essential to observe the following instructions step by step to ensure safe start-up. Start-up may only be conducted by trained specialists.

The standard pump is not suitable for installation in explosion hazard ATEX areas. Please contact us, if you are planning such an application. Before installing the pump you must reliably disconnect it from the electrical power supply and prevent the pump from running up inadvertently.

Observe all safety regulations.

### 3.1 Setting up

The pump must be set up or mounted horizontally on a flat surface. Special mounting is not required.

The pump must be levelled within a tolerance of  $\pm 2$  degrees.

The following ambient operating environment must be observed:

- Pollution degree 2
- Ambient temperature: 18 °C to 40 °C (54 °F to 104 °F),
- Ambient pressure = Atmospheric pressure.
- Rel. humidity  $\leq 95$  % without condensation

In order to avoid over-heating of the pump, an undisturbed fresh airflow to the pump is necessary.

Additional warning note : consider changes in ambient temperatures that might occur when air conditioning is turned down, such as nights and week-ends.

The pump must be kept clean (no dust deposit).

Normal presence of transient over-voltages due to the power mains.

NOTE : the usual transient over-voltage level corresponds to the category II of the impulse withstand (over-voltage) of the IEC 60364-4-443.

### Inlet connection

See safety instructions page 3.

- The inlet flange can be connected with a vacuum-tight flexible hose and/or pipe.
- The pipes should cause no stresses on the pump's flanges. If necessary, compensators must be opened.
- Restriction of the pipes must be avoided in order not to decrease the pumping speed of the pump. The nominal diameter of the pipes has to be at least the same as the diameter of pump's inlet flange.
- When removing condensable vapours, a gas ballast valve must be opened periodically to avoid solvent build up in the oil.
- Additional warning note: additional air flow may be needed during ballast, as this increases pump temperature.
- The inlet pressure must not be above atm. pressure.

See also indications on the pump nameplate.

---

### Warning



---

### Caution

---

### Warning



# Installation

---

## Warning



### Connection to exhaust side

■ No valve or restricting devices should be installed in the exhaust line of the pump. If an exhaust line is installed, it must at least have the same diameter as the exhaust flange. It should be installed in a manner so that no condensate can enter the pump (siphon, slope).

The maximum exhaust pressure must neither exceed 1.15 bar absolute (0.15 bar relative), nor fall under atmosphere pressure minus 15 mbar.

Pump exhaust to be connected if oil mist or process gases are to be avoided in the pump area.

Corresponding pressure regulating devices to be installed by the user.

### 3.2 Electrical connections

Ensure that incoming power to the pump is off before wiring the motor or altering the wiring.

IEC & local electrical regulations must be followed.

Should the pump be connected to a standard wall socket, it must be checked that a building protection rated 16 A is installed (fuse or breaker) to protect the power cable. The frequency converter itself is self-protecting.

Even if the pump is not operating, live voltage is present in the frequency converter !

Voltage and frequency mentioned on the pump nameplate must agree with the supply voltage.

The control cable must be at least distant by 10 cm to the mains cable and crossings shall be at 90°.

Pump control and power supply connection:

See « Ordering information » for the power supply & interface type on the pump.

The power socket and cord are disconnection elements which must remain accessible to the users.

In de-energized condition, plug the mains cable to the pump. Then connect the mains cable to the wall socket or instrument power supply.

---

## Warning

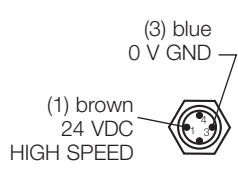

## Control / interface connections for F/C pumps Sub-D9 Pin-out

<p>P/N: 960359V01 960361V01 960362V01 960461V01 ES 960462V01</p> <div style="border: 1px solid black; padding: 5px; margin: 10px 0;"> <p>pin 1: NC pin 2: NC pin 3: Data + pin 4: NC pin 5: GND pin 6: NC pin 7: Data - pin 8: NC pin 9: NC</p> </div> <p>Sub-D female for CONTROL</p>	<p>P/N : 960363V013001 960463V01 960465V013001 960465V013002 960466V01</p> <div style="border: 1px solid black; padding: 5px; margin: 10px 0;"> <p>pin 1: NC pin 2: +24V pin 3: NC pin 4: Low Speed pin 5: NC pin 6: NC pin 7: NC pin 8: High Speed pin 9: +24V</p> </div> <p>Sub-D male Sub-D female for 960466V01</p> <p>For high speed operation, connect 8 and 9. For low speed operation, connect 2 to 4.</p>	<p>P/N : 960363V01</p> 
--	--	--

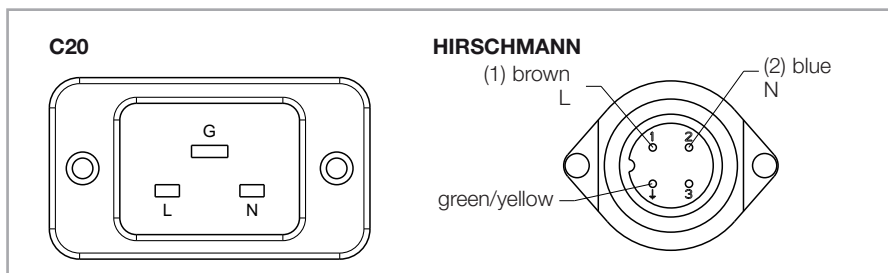
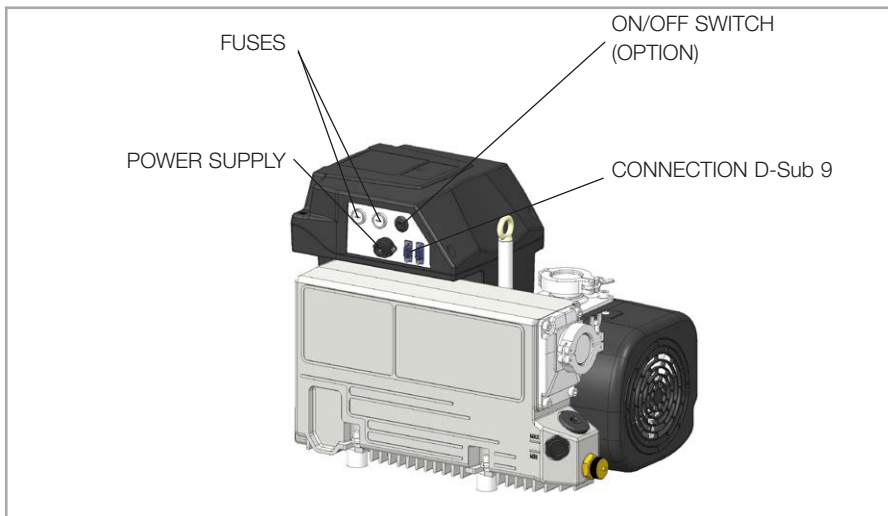

# Operation

The pump is protected against over-currents by two 5X20 mm internal fuses rated 250 V, 12.5 A Time lag T.

The fuse is mounted in a separate housing and can be exchanged from outside using a screwdriver to open the fuse holder cap. See drawing below.

Exchange fuse only with electrically unplugged pump.

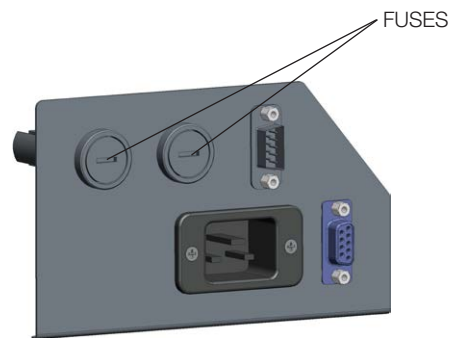

### 3.3 Oil filling

The pump is delivered with its oil inside.

To fill in the oil, unscrew the oil fill plug and fill in until the oil level reaches the "MAX" mark beside the oil sight glass.

1 l oil is needed for the SV40 BI FC .

2 l oil are needed for the SV65 BI FC.

---

## Caution

---

### 3.4 Start-up

Always verify proper oil level before operating the pump.

## 4 Operation

---

## Warning



### 4.1 Operation

To avoid overloading the motor, do not start the pump more than 6 times within one hour. If more than 6 starts per hour are necessary keep the pump running and mount a valve which opens and closes into the intake line.

Take note of warning labels on the pump.

Use ear protection in case of operation at high inlet pressures



## **Pumping of non-condensable gases**

If the pump system contains mainly non condensable gases, the pumps should be operated without gas ballast.

If the composition of the gases to be pumped is not known and if condensation in the pump cannot be ruled out, run the pump with gas ballast valve open in accordance with section below.

## **Pumping of condensable gases and vapors**

With the gas ballast valve open and at operating temperature, the Sogevac® pumps can pump pure water vapor up to the values indicated in the Technical Data.

The gas ballast valve is opened by hand by a knob or a screwdriver on the fan cover or by an EM valve 24 VDC. The running noise of the pump is slightly louder if the gas ballast valve is open. Before pumping vapors ensure that the pump has warmed up for approx. 30 min. with closed intake line and with open gas ballast valve.

Don't open the pump to condensable vapors until it has warmed to operating temperature (approximately); pumping process gas with a cold pump results in vapors condensing in the oil.

One sign of condensation of vapors in the pump is a rise of the oil level during operation of the pump.

When vapors are pumped, the pump must not be switched off immediately after completion of the process because the condensate dissolved in the pump oil may cause changes or corrosion. To prevent this, the pump must continue to operate with open gas ballast valve and closed intake port until the oil is free of condensate. We recommend operating the pump in this mode for at least 30 min. after completion of the process.

Daily ballasting is recommended when continuously pumping larger volumes of condensable vapors.

In cycle operation, the pump should not be switched off between the cycles but should continue to run with gas ballast valve open and intake port closed (if possible via a valve). Power consumption is minimal when the pump is operating at ultimate pressure.

Once all vapors have been pumped off from a process (e. g. during drying), the gas ballast valve can be closed in order to improve the ultimate pressure.

## **4.2 Working in cycles in / out**

We recommend strongly to limit starting of the pump to 5 or 6 per hour.

If the process need it, we recommend utilization of a pneumatic or electromagnetic valve and to let the pump run continuously.

---

### **Caution**

---

### **Note**

---

### 4.3 Switching off / Shutdown

The intake port of the Sogevac® pumps contains an anti-suckback valve which closes the intake port when the pump is switched off, thus maintaining the vacuum in the connected apparatus and preventing oil from being sucked back into the apparatus. The valve's functioning is not impaired by gas ballast operation.

If the pump has to be shutdown, drain the oil flush out the pump with fresh oil and fill in the required amount of clean oil (see § 5.4). Close the connection ports. Special preservation or flushing oils do not need to be used.

---

**Caution**

---

When the pump has been switched off due to over heating, initiated by the motor or its temperature detector, the pump must be cooled down to the ambient temperature, and must only be switched on again manually after having eliminated the cause.

In order to prevent the pump from running up unexpectedly after a mains power failure, the pump must be integrated into the control system in such a way that the pump can only be started by a manual action. This applies equally to emergency cut-off switches.

Close the gasballast.

### 4.4 Conditions of use

The Sogevac® SV BI (FC) pumps are intended to be used on clean processes, at low inlet pressure, e.g. for backing turbo molecular pumps (TMP) in Analytical or R&D applications like mass spectrometers, electronic microscopes, coating installations, etc.

In normal operation, the Sogevac® SV BI (FC) pumps operated typically below 10 mbar inlet pressure or at ultimate pressure with open gas ballast (for pumps having a gas ballast). Continuous duty is possible up to 50 mbar.

In the below listed abnormal conditions (but not limited to) the pump may stop due to overheating of the power electronics or motor.

- Continuous operation at high inlet pressure
- Restricted, clogged or blocked exhaust filter or exhaust line
- Out of tolerance supply voltage
- Unsuitable, polluted or too old oil
- Too low oil level
- Too high ambient temperature
- Clogged fan hoods or impeded fresh air circulation
- Etc.

The pump has been designed & tested to work in a normal EMC environment in acc. to IEC 61326-1 Table 1.

### 4.5 Taking out of use

Please contact Leybold for all relation question about the disposal of spares, consummables or the entire pump

## 5 Maintenance

### 5.1 Safety Information

Observe all safety regulations.

All work must be done by suitably trained personnel. Maintenance or repairs carried out incorrectly will affect the life and performance of the pump and may cause problems when filling warranty claims.

Never mount used seals; always mount new seals.

### 5.2 Maintenance Intervals

The intervals stated in the maintenance schedule are approximate values for normal pump operation. Unfavourable ambient conditions and/or aggressive media may significantly reduce the maintenance intervals.

Maintenance job	Frequency	Section
Check the oil level	Daily	A
Oil changes operation	Annually Longer with LVO700	B
Exhaust filter replacement	Annually Longer with LVO700	C
Gas ballast valve	Monthly checking	D
Anti-suck back valve checking	Annually	E
Fan cover cleaning	Annually	F
Checking the float valve	Annually	G

In order to simplify the maintenance work we recommend to combine several jobs.

Maintenance works must be carried out with proper tools in an adequate work space / bench equipped with sufficient lighting.

Use only Leybold spare & consumables.

An overhaul at Leybold is recommended every 3 years.

After maintenance operations, make sure the device is in a safe condition before putting back into operation.

---

#### Warning



---

#### Caution

---

# Maintenance

## 5.3 Leybold Service

Whenever you send us in equipment, indicate whether the equipment is contaminated or is free of substances which could pose a health hazard.

If it is contaminated, specify exactly which substances are involved. You must use the form we have prepared for this purpose.

A copy of the form has been reproduced at the end of these Operating Instructions: "Declaration of Contamination for Compressors, Vacuum Pumps and Components". Another suitable form is available from [www.leybold.com](http://www.leybold.com) → Downloads → Download Documents.

Attach the form to the equipment or enclose it with the equipment.

This statement detailing the type of contamination is required to satisfy legal requirements and for the protection of our employees.

We must return to the sender any equipment which is not accompanied by a contamination statement.

---

### Caution

The pump must be packaged in such a way that it will not be damaged during shipping, and so that no harmful substances can escape from the package.

When disposing of used oil, please observe the relevant environmental regulations.

---

## 5.4 Maintenance Work

### Checking the oil

#### A. Oil level

The oil level shall be checked at least once a day and must be, while the pump is in operation, close to the MAX marks. Should the oil level be below the MIN mark switch off the pump, check it (see chapter 4) and add the required amount of oil.

Oil level may drop when pump is operating due to oil distribution in the pump.

#### B. Oil Change

Oil must be changed typically after the first year of service. Further oil changes must be done annually. If there is considerable pollution, it could be necessary to change the oil more frequently.

Oil changing must be done with **a switched off and still warm pump**. Open the oil drain plug and let the used oil run out into an appropriate container. Refasten the oil drain plug when oil runs sloup the pump briefly (5 sec. max.) and switch of immediately. Reopen the oil drain plug and drain the rest of the oil.

Additional warning note: more frequent oil changes may be necessary if the ambient temperature is above 30 °C.

Before refastening the oil drain plug, inspect the o-ring and verify that it is free of particulate and is seated properly. Replace if necessary.

The pump should be "flushed" if there is considerable pollution.

---

### Warning



To flush the pump, for clean oil up to the minimum level, let the pump run for a few minutes and drain the oil. Install a full charge of oil.

When disposing of used oil, please observe the relevant environmental regulations.

## **C. Replacing the exhaust filters**

Oil mist escaping from the exhaust during operation indicates that the filter is probably clogged. Increased energy intake by the motor could also be the result of a soiled exhaust filter. Pump switched off, open the exhaust hood, take out the filter and replace it. Also check the gasket of the exhaust flange and change it if necessary.

Take care about hot oil ! Risk of burning by touching !

## **D. Gas ballast valve cleaning**

Contact Leybold.

Clean the membrane, the seat and the knob.

Reassemble in the reverse sequence.

## **E. Anti-suck back valve checking**

The anti-suck back valve should be checked at the same time as the inlet flange sifter and if dirty, be cleaned with an appropriate solvent.

Also check, if there is no damage on the sealing part of the valve.

## **F. Fan cover cleaning**

Soiling of the fan cover may lead to overheating of the motor and the pump.

Put off the cover and clean it with blast air.

Before starting the pump again, be sure that the cover has been reassembled.

## **G. Checking the float valve**

When replacing the exhaust filter, check the cleanliness and the proper operation of the float valve. After having disassembled the exhaust flange and oil casing, remove screw, pull on the float valve, clean the nozzle and check that the float itself oscillates free around its axle and that the valve is tight. Clean the float chamber of the oil casing. Reassemble in the reverse sequence.

---

### **Warning**



---

### **Caution**

---

# Troubleshooting

## 6 Troubleshooting

<b>Fault</b>	<b>Possible cause</b>	<b>Remedy</b>	<b>Reference section *</b>
Pump does not start.	Pump is connected incorrectly.	Connect the pump correctly.	3.3
	Motor protection switch incorrectly set.	change fuse.	3.3
	Operating voltage does not match motor. Motor is malfunctioning. Oil temperature is below 12 °C (54 °F).	Replace the motor. Replace the motor. Heat the pump and pump oil or use different oil.	1.4
	Oil is too viscous. Exhaust filter / exhaust line is clogged.	Use appropriate oil grade. Replace the filter or clean the exhaust line.	5.4-B 5.4-D
Pump does not reach ultimate pressure.	External leak	Repair the pump.	
	Float valve does not close.	Repair the valve.	5.4-H
	Anti-suckback valve is malfunctioning.	Repair the valve.	5.4-F
	Inadequate lubrication due to:		
	■ unsuitable or contaminated oil,	Change the oil (degas it, if necessary).	5.4-C
	■ clogged oil filter,	Replace the oil filter.	5.4-C
	■ clogged oil lines.	Clean the oil casing.	
Vacuum lines are dirty.	Clean vacuum lines.		
Pump is too small.	Check the process date; replace the pump, if necessary.		
Pumping speed is too low.		Precaution : install a dust filter in intake line.	
	Exhaust filter is clogged.	Install new filter elements.	5.4-D
	Connecting lines are too narrow or too long.	Use adequately wide and short connecting lines.	3.2
	Anti-suckback valve is hard to open.	Check spring free length.	
After switching off pump under vacuum, pressure in system rises too fast.	System has a leak.	Check the system.	
	Anti-suckback is malfunctioning.	Repair the valve.	5.4-F
Pump gets too hot	Cooling air supply is obstructed.	Set pump up correctly.	3.1
	Cooler is dirty.	Clean the cooler.	
	Ambient temperature is too high.	Set pump up correctly.	3.1
	Process gas is too hot.	Change the process.	
	Oil level is too low.	Add oil to reach the correct oil level.	5.4-C
	Oil is unsuitable.	Change the oil.	5.4-C
	Oil cycle is obstructed.	Clean or repair the oil lines.	
	Exhaust filter / exhaust line is obstructed.	Replace the exhaust filter, clean the exhaust line.	5.4-D
Pump module is no longer usable.	Replace the pump module.	5.4-K	

# Troubleshooting

<b>Fault</b>	<b>Possible cause</b>	<b>Remedy</b>	<b>Reference section *</b>
Oil in intake line or in vacuum vessel.	Oil comes from the vacuum system.	Check the vacuum system.	
	Anti-suckback valve is obstructed.	Clean or repair the valve.	5.4-F
	Sealing surfaces of anti-suckback valve are damaged or dirty.	Clean or repair the intake port and valve.	5.4-F
Pump's oil consumption too high, oil mist at exhaust.	Oil level is too high.	Drain the excess oil.	5.4-B
	Exhaust filters are clogged or damaged.	Replace the filters.	5.4-C
	Nozzle of float valve is clogged.	Check the valve, clean the nozzle.	5.4
Oil is turbid.	Oil level is too high.	Drain the excess oil.	5.4-B
	Condensation.	Degas the oil or change the oil and clean the pump. Precaution : open the gas ballast valve or insert a condensate trap.	4.1/5.4-B
		Clean the gas ballast intake filter.	5.4-G
Pump is excessively noisy.	Oil level is very low (oil is no longer visible).	Add oil.	5.4-B
	Oil filter is clogged.	Change the oil and filter.	5.4-B
	Large vacuum leak in system.	Repair vacuum leak. Contact Leybold.	

\* Reference section : This column refers to the section in the Operating Instructions that contains the applicable repair information.

Never mount used seals. Always mount new seals.

# Spare parts

## 7 Spare parts

To guarantee safe operation of the Leybold pump, only original spare parts and accessories should be used. When ordering spare parts and accessories, always state pump type and serial number. You can find part numbers in the spare parts list.

Consummables and main spare parts kits for Sogevac® pumps are usually available on stock at Leybold's service centers. The list of these parts is given hereafter and in the spare parts table where the contents of each kit is detailed.

- Exhaust demisters
- Oil
- Service kit
- Set of seals
- Repair kit

We recommend to use these kits which have been defined to allow an optimal maintenance or repair. Individual spare parts may need longer delivery time.



# Spare parts

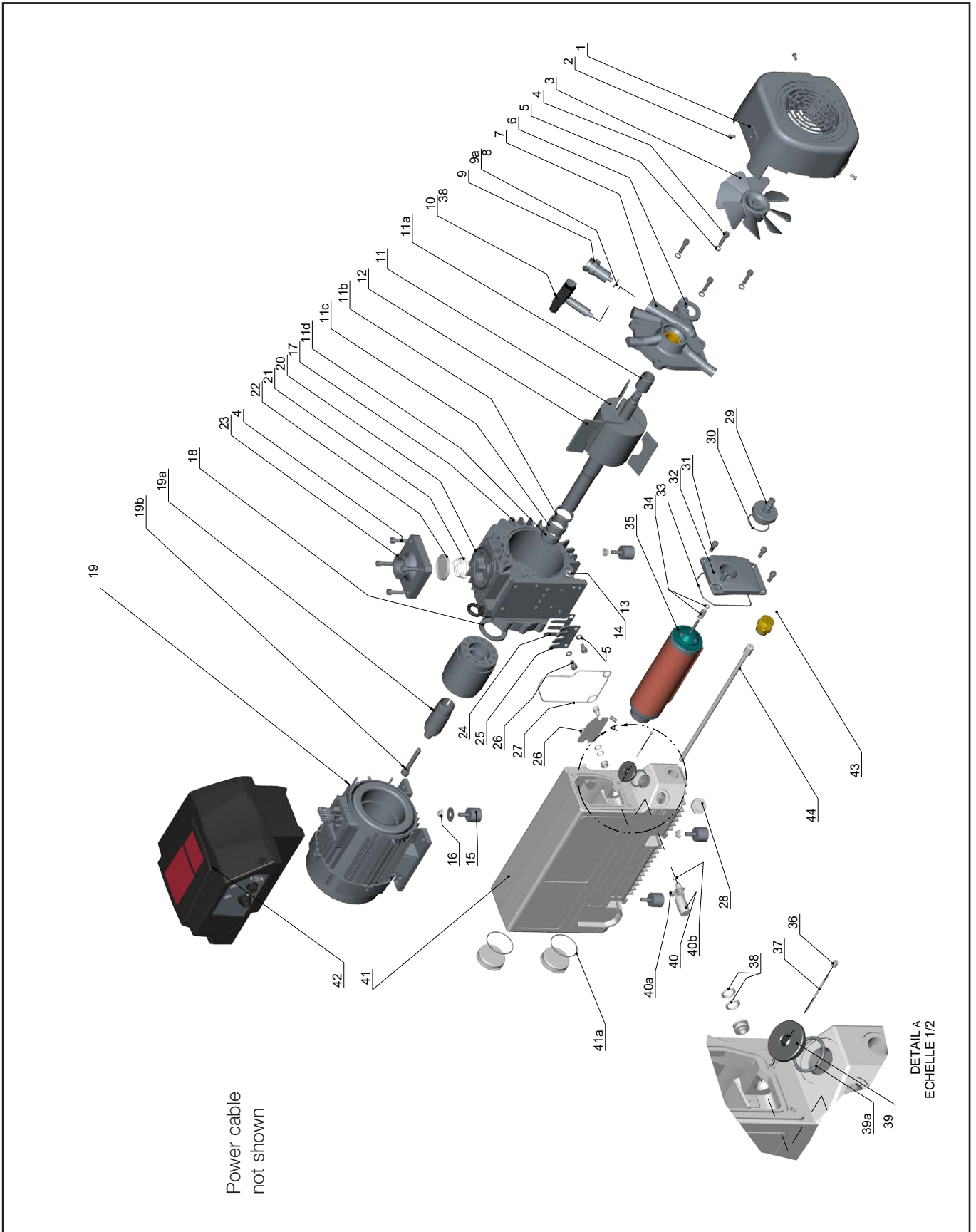



# EU Declaration of Conformity

(Translation of original Declaration of Conformity)

**The manufacturer:** Leybold GmbH  
Bonner Strasse 498  
D-50968 Köln  
Germany

herewith declares that the products specified and listed below which we have placed on the market, comply with the applicable EU Council Directives. This declaration becomes invalid if modifications are made to the product without agreement of Leybold GmbH.

**Product designation:** SOGEVAC  
**Type designation:** SV16, SV25, SV16D, SV25D, SV200, SV1200, SV16B, SV25B, SV40B, SV65B, SV100B, SV120B (I FC), SV300B, SV470B, SV500B, SV570B, SV630B, SV750B, SV28BI (FC), SV40BI (FC), SV65BI (FC), and their variants, excepted pumps delivered without motor

**The products complies to the following European Council Directives:**

Machinery Directive (2006/42/EC)

The safety objectives of the Low Voltage Directive 2014/35/EU were complied with in accordance with Appendix 1 No. 1.5.1 of Machinery Directive 2006/42/EC.

Electromagnetic Compatibility (2014/30/EU)

RoHS Directive (2011/65/EU) & (2015/863/EU)

**The following harmonized standards have been applied:**

EN 1012-2:1996+A1:2009	Compressors and vacuum pumps — Safety requirements — Part 2: Vacuum pumps
EN 60204-1:2006/A1:2009	Safety of machinery — Electrical equipment of machines — Part 1: General requirements requirements
EN 61000-6-2:2005/AC:2005	Electromagnetic compatibility (EMC) - Part 6-2: Generic standards - Immunity for industrial environments
EN 61000-6-4:2007/A1:2011	Electromagnetic compatibility (EMC) - Part 6-4: Generic standards - Emission standard for industrial environments

**Documentation officer:** Herbert Etges  
T: +49(0)221 347 0  
F: +49(0)221 347 1250  
documentation@leybold.com

Cologne, November 14, 2016

Cologne, November 14, 2016



ppa. Martin Tollner  
Head of Product Lines

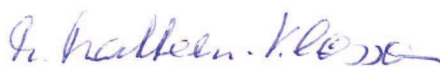

ppa. Dr. Monika Mattern-Klosson  
Head of Quality & Business Process Management

## Declaration of Contamination of Compressors, Vacuum Pumps and Components

The repair and / or servicing of compressors, vacuum pumps and components will be carried out only if a correctly completed declaration has been submitted. Non-completion will result in delay. The manufacturer can refuse to accept any equipment without a declaration.

**A separate declaration has to be completed for each single component.**

This declaration may be completed and signed only by authorized and qualified staff.

Customer/Dep./Institute : _____ Address : _____ _____ Person to contact: _____ Phone : _____ Fax: _____ End user: _____	Reason for return: <input checked="" type="checkbox"/> applicable please mark <b>Repair:</b> <input type="checkbox"/> chargeable <input type="checkbox"/> warranty <b>Exchange:</b> <input type="checkbox"/> chargeable <input type="checkbox"/> warranty <input type="checkbox"/> Exchange already arranged / received <b>Return only:</b> <input type="checkbox"/> rent <input type="checkbox"/> loan <input type="checkbox"/> for credit <b>Calibration:</b> <input type="checkbox"/> DKD <input type="checkbox"/> Factory-calibr. <input type="checkbox"/> Quality test certificate DIN 55350-18-4.2.1
--	--

<b>A. Description of the Leybold product:</b> Material description : _____ Catalog number: _____ Serial number: _____ Type of oil (ForeVacuum-Pumps) : _____	<b>Failure description:</b> _____ <b>Additional parts:</b> _____ <b>Application-Tool:</b> _____ <b>Application- Process:</b> _____
--	---

B. Condition of the equipment	No <sup>1)</sup>	Yes	No	Contamination :	No <sup>1)</sup>	Yes
1. Has the equipment been used	<input type="checkbox"/>	<input type="checkbox"/>	<input checked="" type="checkbox"/>	toxic	<input type="checkbox"/>	<input type="checkbox"/>
2. Drained (Product/service fluid)	<input checked="" type="checkbox"/>	<input type="checkbox"/>	<input type="checkbox"/>	corrosive	<input type="checkbox"/>	<input type="checkbox"/>
3. All openings sealed airtight	<input checked="" type="checkbox"/>	<input type="checkbox"/>	<input type="checkbox"/>	flammable	<input type="checkbox"/>	<input type="checkbox"/>
4. Purged	<input checked="" type="checkbox"/>	<input type="checkbox"/>	<input type="checkbox"/>	explosive <sup>2)</sup>	<input type="checkbox"/>	<input type="checkbox"/>
If yes, which cleaning agent				radioactive <sup>2)</sup>	<input type="checkbox"/>	<input type="checkbox"/>
and which method of cleaning				microbiological <sup>2)</sup>	<input type="checkbox"/>	<input type="checkbox"/>
<sup>1)</sup> If answered with "No", go to D.				other harmful substances	<input type="checkbox"/>	<input type="checkbox"/>

<b>C. Description of processed substances (Please fill in absolutely)</b> 1. What substances have come into contact with the equipment ? Trade name and / or chemical term of service fluids and substances processed, properties of the substances According to safety data sheet (e.g. toxic, inflammable, corrosive, radioactive)																															
<table border="1" style="width:100%; border-collapse: collapse;"> <tr> <th style="width:5%;">X</th> <th style="width:30%;">Tradename:</th> <th style="width:65%;">Chemical name:</th> </tr> <tr><td> </td><td> </td><td> </td></tr> <tr><td>a)</td><td> </td><td> </td></tr> <tr><td>b)</td><td> </td><td> </td></tr> <tr><td>c)</td><td> </td><td> </td></tr> <tr><td>d)</td><td> </td><td> </td></tr> </table>	X	Tradename:	Chemical name:				a)			b)			c)			d)			<table border="1" style="width:100%; border-collapse: collapse;"> <tr> <th style="width:50%;"></th> <th style="width:10%; text-align: center;">No</th> <th style="width:10%; text-align: center;">Yes</th> </tr> <tr> <td>2. Are these substances harmful ?</td> <td style="text-align: center;"><input type="checkbox"/></td> <td style="text-align: center;"><input type="checkbox"/></td> </tr> <tr> <td>3. Dangerous decomposition products when heated ?</td> <td style="text-align: center;"><input type="checkbox"/></td> <td style="text-align: center;"><input type="checkbox"/></td> </tr> <tr> <td>  If yes, which ? _____</td> <td colspan="2"></td> </tr> </table>		No	Yes	2. Are these substances harmful ?	<input type="checkbox"/>	<input type="checkbox"/>	3. Dangerous decomposition products when heated ?	<input type="checkbox"/>	<input type="checkbox"/>	If yes, which ? _____		
X	Tradename:	Chemical name:																													
a)																															
b)																															
c)																															
d)																															
	No	Yes																													
2. Are these substances harmful ?	<input type="checkbox"/>	<input type="checkbox"/>																													
3. Dangerous decomposition products when heated ?	<input type="checkbox"/>	<input type="checkbox"/>																													
If yes, which ? _____																															

<sup>2)</sup> Components contaminated by microbiological, explosive or radioactive products/substances will not be accepted without written evidence of decontamination.

### D. Legally binding declaration

I / we hereby declare that the information supplied on this form is accurate and sufficient to judge any contamination level.

Name of authorized person (block letters) : \_\_\_\_\_

\_\_\_\_\_

Date

signature of authorized person

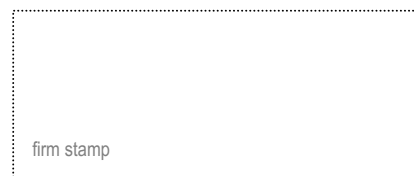





# Sales and Service

## Germany

### Leybold GmbH

Sales, Service, Support Center (3SC)  
Bonner Strasse 498  
D-50968 Cologne  
T: +49-(0)221-347 1234  
F: +49-(0)221-347 31234  
sales@leybold.com  
www.leybold.com

### Leybold GmbH

**Sales Area North**  
Branch Office Berlin  
Industriestrasse 10b  
D-12099 Berlin  
T: +49-(0)30-435 609 0  
F: +49-(0)30-435 609 10  
sales.bn@leybold.com

### Leybold GmbH

**Sales Office South**  
Branch Office Munich  
Karl-Hammerschmidt-Strasse 34  
D-85609 Aschheim-Dornach  
T: +49-(0)89-357 33 9-10  
F: +49-(0)89-357 33 9-33  
sales.mn@leybold.com  
service.mn@leybold.com

### Leybold Dresden GmbH

**Service Competence Center**  
Zur Wetterwarte 50, Haus 304  
D-01109 Dresden  
Service:  
T: +49-(0)351-88 55 00  
F: +49-(0)351-88 55 041  
info.dr@leybold.com

## Europe

### Belgium

#### Leybold Nederland B.V.

**Belgisch bijkantoor**  
Leuvensesteenweg 542-9A  
B-1930 Zaventem  
Sales:  
T: +32-2-711 00 83  
F: +32-2-720 83 38  
sales.zv@leybold.com  
Service:  
T: +32-2-711 00 82  
F: +32-2-720 83 38  
service.zv@leybold.com

### France

#### Leybold France S.A.S.

Parc du Technopolis, Bâtiment Beta  
3, Avenue du Canada  
F-91940 Les Ulis cedex  
Sales and Service:  
T: +33-1-69 82 48 00  
F: +33-1-69 07 57 38  
info.ctb@leybold.com  
sales.ctb@leybold.com

#### Leybold France S.A.S.

Valence Factory  
640, Rue A. Bergès  
B.P. 107  
F-26501 Bourg-lès-Valence Cedex  
T: +33-4-75 82 33 00  
F: +33-4-75 82 92 69  
marketing.vc@leybold.com

## Great Britain

### Leybold UK LTD.

Unit 9  
Silverglade Business Park  
Leatherhead Road  
Chessington  
Surrey (London)  
KT9 2QL  
Sales:  
T: +44-13-7273 7300  
F: +44-13-7273 7301  
sales.ln@leybold.com  
Service:  
T: +44-13-7273 7320  
F: +44-13-7273 7303  
service.ln@leybold.com

### Italy

#### Leybold Italia S.r.l.

Via Filippo Brunelleschi 2  
I-20093 Cologno Monzese  
Sales:  
T: +39-02-27 22 31  
F: +39-02-27 20 96 41  
sales.mi@leybold.com  
Service:  
T: +39-02-27 22 31  
F: +39-02-27 22 32 17  
service.mi@leybold.com

### Netherlands

#### Leybold Nederland B.V.

Floridadreef 102  
NL-3565 AM Utrecht  
Sales and Service:  
T: +31-(30) 242 63 30  
F: +31-(30) 242 63 31  
sales.ut@leybold.com  
service.ut@leybold.com

### Switzerland

#### Leybold Schweiz AG

Hinterbergstrasse 56  
CH-6312 Steinhausen  
Warehouse and shipping address:  
Riedthofstrasse 214  
CH-8105 Regensdorf  
Sales:  
T: +41-44-308 40 50  
F: +41-44-302 43 73  
sales.zh@leybold.com  
Service:  
T: +41-44-308 40 62  
F: +41-44-308 40 60  
service.zh@leybold.com

### Spain

#### Leybold Hispánica, S.A.

C/. Huelva, 7  
E-08940 Cornellá de Llobregat  
(Barcelona)  
Sales:  
T: +34-93-666 43 11  
F: +34-93-666 43 70  
sales.ba@leybold.com  
Service:  
T: +34-93-666 46 11  
F: +34-93-685 43 70  
service.ba@leybold.com

## Headquarter

### Leybold GmbH

Bonner Strasse 498  
D-50968 Cologne  
T: +49-(0)221-347-0  
F: +49-(0)221-347-1250  
info@leybold.com

## America

### USA

#### Leybold USA Inc.

5700 Mellon Road  
USA-Export, PA 15632  
T: +1-724-327-5700  
F: +1-724-325-3577  
info.ex@leybold.com  
Sales:  
T: +1-724-327-5700  
F: +1-724-333-1217  
Service:  
T: +1-724-327-5700  
F: +1-724-325-3577

### Brazil

#### Leybold do Brasil

Rod. Vice-Prefeito Hermenegildo Tonolli,  
nº. 4413 - 6B  
Distrito Industrial  
Jundiá - SP  
CEP 13.213-086  
Sales and Service:  
T: +55 11 99467 5380  
F: +55 11 99467 5934  
sales.ju@leybold.com  
service.ju@leybold.com

## Asia

### P. R. China

#### Leybold (Tianjin)

**International Trade Co. Ltd.**  
Beichen Economic  
Development Area (BEDA),  
No. 8 Western Shuangchen Road  
Tianjin 300400  
China  
Sales and Service:  
T: +86-400 038 8989  
T: +86-800 818 0033  
F: +86-22-2697 4061  
F: +86-22-2697 2017  
sales.tj@leybold.com  
service.tj@leybold.com

### India

#### Leybold India Pvt Ltd.

T-97/2, MIDC Bhosari  
Pune-411 026  
India  
Sales and Service:  
T: +91-80-2783 9925  
F: +91-80-2783 9926  
sales.bgl@leybold.com  
service.bgl@leybold.com

### Japan

#### Leybold Japan Co., Ltd.

Headquarters  
Shin-Yokohama A.K.Bldg., 4th floor  
3-23-3, Shin-Yokohama  
Kohoku-ku, Yokohama-shi  
Kanagawa-ken 222-0033  
Japan  
Sales:  
T: +81-45-471-3330  
F: +81-45-471-3323  
sales.yh@leybold.com

### Leybold Japan Co., Ltd.

Tsukuba Technical Service Center  
1959, Kami-yokoba  
Tsukuba-shi, Ibaraki-shi 305-0854  
Japan  
Service:  
T: +81-29 839 5480  
F: +81-29 839 5485  
service.iik@leybold.com

### Malaysia

#### Leybold Malaysia

#### Leybold Singapore Pte Ltd.

No. 1 Jalan Hi-Tech 2/6  
Kulim Hi-Tech Park  
Kulim, Kedah Darul  
Aman 09000  
Malaysia  
Sales and Service:  
T: +604 4020 222  
F: +604 4020 221  
sales.ku@leybold.com  
service.ku@leybold.com

### South Korea

#### Leybold Korea Ltd.

3F. Jellzone 2 Tower  
Jeongja-dong 159-4  
Bundang-gu Sungnam-si  
Gyeonggi-do  
Bundang 463-384, Korea  
Sales:  
T: +82-31 785 1367  
F: +82-31 785 1359  
sales.bd@leybold.com  
Service:  
623-7, Upsung-Dong  
Cheonan-Si  
Chungcheongnam-Do  
Korea 330-290  
T: +82-41 589 3035  
F: +82-41 588 0166  
service.cn@leybold.com

### Singapore

#### Leybold Singapore Pte Ltd.

42 Loyang Drive  
Loyang Industrial Estate  
Singapore 508962  
Singapore  
Sales and Service:  
T: +65-6303 7030  
F: +65-6773 0039  
sales.sg@leybold.com  
service.sg@leybold.com

### Taiwan

#### Leybold Taiwan Ltd.

10F., No. 32, Chenggong 12th St.,  
Zhubei City, Hsinchu County 302  
Taiwan, R.O.C.  
Sales and Service:  
T: +886-3-500 1688  
F: +886-3-583 3999  
sales.hc@leybold.com  
service.hc@leybold.com



www.leybold.com